

# SPEC

Spec No.	TQ3C-8EAF0-E1YAW02-00
Date	August 5, 2013

## **TYPE : T-55923GD050J-LW-ABN** **(TCG050VGLP\*ANN-AN\*02)**

< 5.0 inch VGA transmissive color TFT with LED backlight >

### CONTENTS

1. Application
2. Construction and outline
3. Mechanical specifications
4. Absolute maximum ratings
5. Electrical characteristics
6. Optical characteristics
7. Interface signals
8. Input timing characteristics
9. Backlight characteristics
10. Lot number identification
11. Warranty
12. Precautions for use
13. Reliability test data
14. Outline drawing

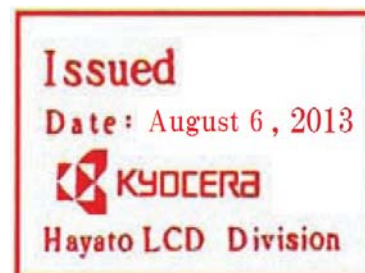

KYOCERA DISPLAY CORPORATION

This specification is subject to change without notice.  
Consult Kyocera before ordering.

Original Issue Date	Designed by: Engineering dept.			Confirmed by: QA dept.	
	Prepared	Checked	Approved	Checked	Approved
August 5, 2013	<i>K. Mori</i>	<i>Y. Yamazaki</i>	<i>M. Fujitani</i>	<i>O. Sato</i>	<i>T. Okamoto</i>

## **Warning**

1. This Kyocera LCD module has been specifically designed for use only in electronic devices and industrial machines in the area of audio control, office automation, industrial control, home appliances, etc. The module should not be used in applications where the highest level of safety and reliability are required and module failure or malfunction of such module results in physical harm or loss of life, as well as enormous damage or loss. Such fields of applications include, without limitation, medical, aerospace, communications infrastructure, atomic energy control. Kyocera expressly disclaims any and all liability resulting in any way to the use of the module in such applications.
  
2. Customer agrees to indemnify, defend and hold Kyocera harmless from and against any and all actions, claims, damages, liabilities, awards, costs, and expenses, including legal expenses, resulting from or arising out of Customer's use, or sale for use, or Kyocera modules in applications.

## **Caution**

1. Kyocera shall have the right, which Customer hereby acknowledges, to immediately scrap or destroy tooling for Kyocera modules for which no Purchase Orders have been received from the Customer in a two-year period.



## 1. Application

This document defines the specification of T-55923GD050J-LW-ABN. (RoHS Compliant)

## 2. Construction and outline

LCD	: Transmissive color dot matrix type TFT
Backlight system	: LED
Polarizer	: Glare treatment
Additional circuit	: Timing controller, Power supply (3.3V input) (without constant current circuit for LED Backlight)

## 3. Mechanical specifications

Item	Specification	Unit
Outline dimensions 1)	98.0(W)×119.0(H)×10.5(D)	mm
Active area	76.32(W)×101.76(H) (12.72cm/5.0 inch(Diagonal))	mm
Dot format	480(W)×640×(R,G,B)(H)	dot
Dot pitch	0.159(W)×0.053(H)	mm
Base color 2)	Normally White	-
Mass	185	g

1) Projection not included. Please refer to outline for details.

2) Due to the characteristics of the LCD material, the color varies with environmental temperature.

## 4. Absolute maximum ratings

### 4-1. Electrical absolute maximum ratings

Item	Symbol	Min.	Max.	Unit
Supply voltage	V <sub>DD</sub>	(-0.3)	(4.0)	V
Input signal voltage 1)	V <sub>IN</sub>	(0)	(V <sub>DD</sub> )	V
LED forward current 2) 3)	I <sub>F</sub>	-	(70)	mA

- 1) Input signal : DCLK, R0~R7, G0~G7, B0~B7, HD, VD, DENA
- 2) For each "AN-CA"
- 3) Do not apply reversed voltage.

### 4-2. Environmental absolute maximum ratings

Item	Symbol	Min.	Max.	Unit
Operating temperature 1)	T <sub>OP</sub>	(-30)	(80)	°C
Storage temperature 2)	T <sub>STO</sub>	(-30)	(80)	°C
Operating humidity 3)	H <sub>OP</sub>	(10)	4)	%RH
Storage humidity 3)	H <sub>STO</sub>	(10)	4)	%RH
Vibration	-	5)	5)	-
Shock	-	6)	6)	-

- 1) Operating temperature means a temperature which operation shall be guaranteed. Since display performance is evaluated at 25°C, another temperature range should be confirmed.
- 2) Temp. = (-30)°C < (48)h , Temp. = (80)°C < (168)h  
Store LCD at normal temperature/humidity. Keep them free from vibration and shock.  
An LCD that is kept at a low or a high temperature for a long time can be defective due to other conditions, even if the low or high temperature satisfies the standard.  
(Please refer to "Precautions for Use" for details.)
- 3) Non-condensing
- 4) Temp. ≤ (40)°C, (85)%RH Max.  
Temp. > (40)°C, Absolute humidity shall be less than (85)%RH at (40)°C.
- 5) Vibration level 9.8m/s<sup>2</sup>(1.0G)  
Waveform : sinusoidal  
Frequency range : 5 to 500Hz  
Frequency sweep rate : 0.5 octave/min  
Duration : one sweep from 5to 500Hz in each of three mutually perpendicular axis(total 3 hours)
- 6) Acceleration: 1,470 m/s<sup>2</sup>(150G), Waveform : half sinusoidal wave 2ms  
3 times in each direction: ±X, ±Y, ±Z



## 6. Optical characteristics

Measuring spot =  $\phi$  6.0mm, Temp. = 25°C

Item	Symbol	Condition	Min.	Typ.	Max.	Unit	
Response time	Rise	$\tau_r$	$\theta = \phi = 0^\circ$	-	(4)	-	ms
	Down	$\tau_d$	$\theta = \phi = 0^\circ$	-	(12)	-	ms
Viewing angle range View direction : 6 o'clock (Gray inversion)	$\theta$ UPPER	CR $\geq$ 10	-	(50)	-	deg.	
	$\theta$ LOWER		-	(60)	-		
	$\phi$ LEFT		-	(70)	-	deg.	
	$\phi$ RIGHT		-	(70)	-		
Contrast ratio	CR	$\theta = \phi = 0^\circ$	(350)	(500)	-	-	
Brightness	L	IF=60mA/Line	(600)	(800)	-	cd/m <sup>2</sup>	
Chromaticity coordinates	Red	x	$\theta = \phi = 0^\circ$	(0.509)	(0.549)	(0.589)	-
		y		(0.316)	(0.356)	(0.396)	
	Green	x	$\theta = \phi = 0^\circ$	(0.299)	(0.339)	(0.379)	
		y		(0.499)	(0.539)	(0.579)	
	Blue	x	$\theta = \phi = 0^\circ$	(0.114)	(0.154)	(0.194)	
		y		(0.090)	(0.130)	(0.170)	
	White	x	$\theta = \phi = 0^\circ$	(0.273)	(0.313)	(0.353)	
		y		(0.289)	(0.329)	(0.369)	

### 6-1. Definition of contrast ratio

$$\text{CR(Contrast ratio)} = \frac{\text{Brightness with all pixels "White"}}{\text{Brightness with all pixels "Black"}}$$

### 6-2. Definition of response time

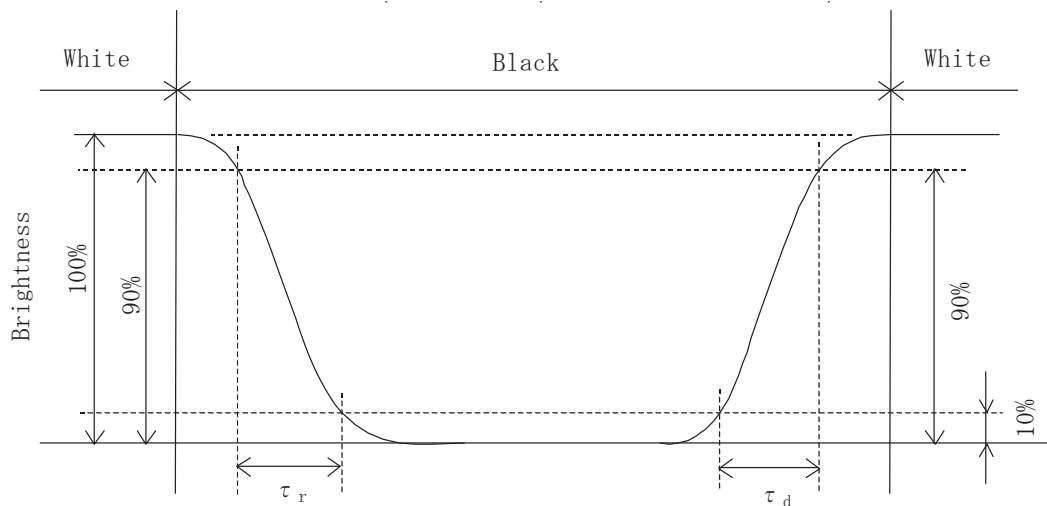

6-3. Definition of viewing angle

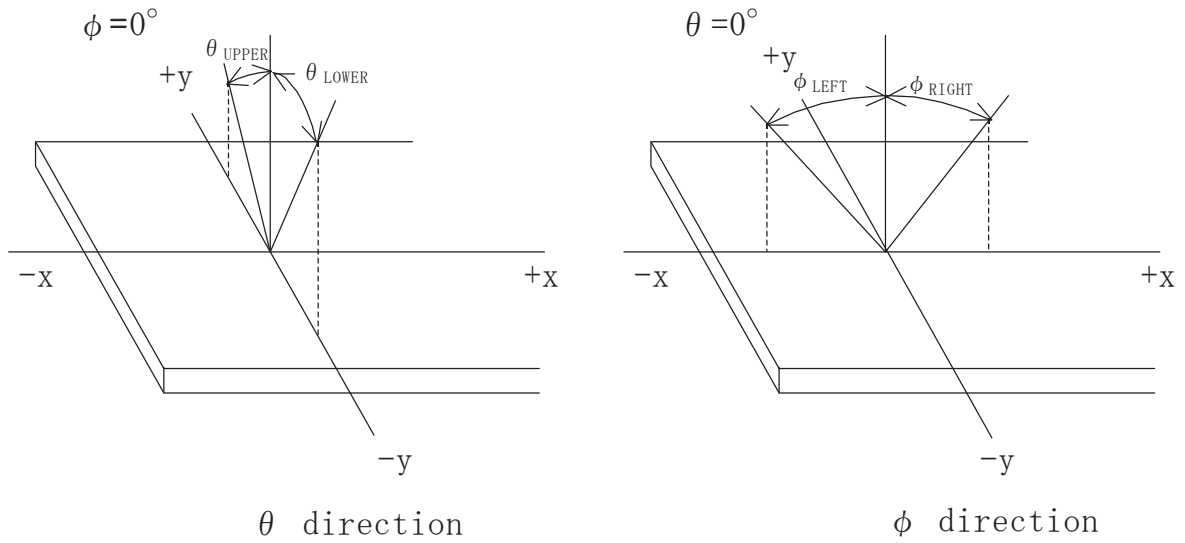

6-4. Brightness measuring points

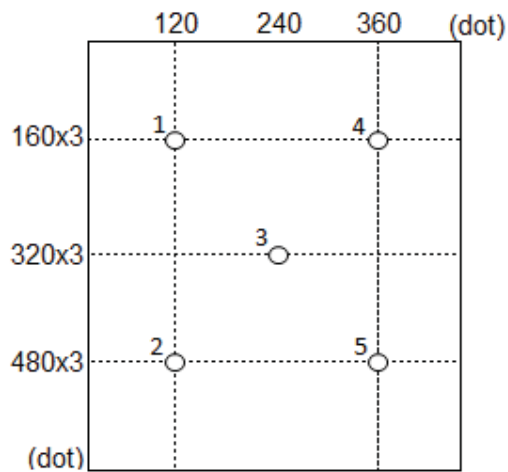

- 1) Rating is defined as the white brightness at center of display screen(3).
- 2) 5 minutes after LED is turned on. (Ambient Temp.=25°C)



## 7. Interface signals

### 7-1. Interface signals

No.	Symbol	Description	I/O	Note
1	GND	GND	-	
2	DCLK	Clock signal for sampling each data signal	I	
3	GND	GND	-	
4	HD	Horizontal synchronous signal	I	
5	VD	Vertical synchronous signal	I	
6	GND	GND	-	
7	R0	RED data signal (LSB)	I	
8	R1	RED data signal	I	
9	R2	RED data signal	I	
10	R3	RED data signal	I	
11	R4	RED data signal	I	
12	R5	RED data signal	I	
13	R6	RED data signal	I	
14	R7	RED data signal (MSB)	I	
15	GND	GND	-	
16	G0	GREEN data signal (LSB)	I	
17	G1	GREEN data signal	I	
18	G2	GREEN data signal	I	
19	G3	GREEN data signal	I	
20	G4	GREEN data signal	I	
21	G5	GREEN data signal	I	
22	G6	GREEN data signal	I	
23	G7	GREEN data signal (MSB)	I	
24	GND	GND	-	
25	B0	BLUE data signal (LSB)	I	
26	B1	BLUE data signal	I	
27	B2	BLUE data signal	I	
28	B3	BLUE data signal	I	
29	B4	BLUE data signal	I	
30	B5	BLUE data signal	I	
31	B6	BLUE data signal	I	
32	B7	BLUE data signal (MSB)	I	
33	GND	GND	-	
34	DENA	Signal to settle the horizontal display position	I	1)
35	NC	No connect	-	
36	V <sub>DD</sub>	3.3V power supply	-	
37	V <sub>DD</sub>	3.3V power supply	-	
38	NC	No connect	-	
39	NC	No connect	-	
40	SC	Scan direction control	I	2)
41	NC	No connect	-	
42	CA1	Cathode 1	-	
43	CA2	Cathode 2	-	
44	AN2	Anode 2	-	
45	AN1	Anode 1	-	

LCD connector : FH33-45S-0.5SH(10) (HIROSE)

Recommended FFC or FPC : 0.5mm pitch

- 1) The horizontal display start timing is settled in accordance with a rising timing of ENAB signal.  
In case ENAB is fixed "Low", the horizontal start timing is determined.  
Don't keep ENAB "High" during operation.
- 2) TBD

#### 7-2. Test Pad

TEST PAD No.	Interface Signal	
	No.	Symbol
1	14	R7(MSB)
2	1	GND
3	23	G7(MSB)
4	2	DCLK
5	32	B7(MSB)
6	4	HD
7	34	DENA
8	5	VD
9	36	V <sub>DD</sub>
10	42	CA1
11	43	CA2
12	44	AN2
13	45	AN1

## 8. Input timing characteristics

### 8-1. Timing characteristics

#### 1) Horizontal timing

Parameter	Symbol	Spec.			Unit
		Min.	Typ.	Max.	
Horizontal Display Area	thd	640			DCLK
DCLK frequency	fclk	-	24	50	MHz
One Horizontal Line	th	760			DCLK
HS pulse width	thpw	1	48	255	DCLK
HS Back Porch (Blanking)	thb	88			DCLK
HS Front Porch	thfp	1	32	255	DCLK
DE mode Blanking	th-thd	85	120	512	DCLK

#### 2) Vertical timing

Parameter	Symbol	Spec.			Unit
		Min.	Typ.	Max.	
Vertical Display Area	tvd	480			T <sub>H</sub>
VS period time	tv	513	525	767	T <sub>H</sub>
VS pulse width	tvpw	3	3	255	T <sub>H</sub>
VS Back Porch (Blanking)	tvb	32			T <sub>H</sub>
VS Front Porch	tvfp	1	13	255	T <sub>H</sub>
DE mode Blanking	tv-tvd	4	45	255	T <sub>H</sub>

### 8-2. Input Data Signals and Display position on the screen

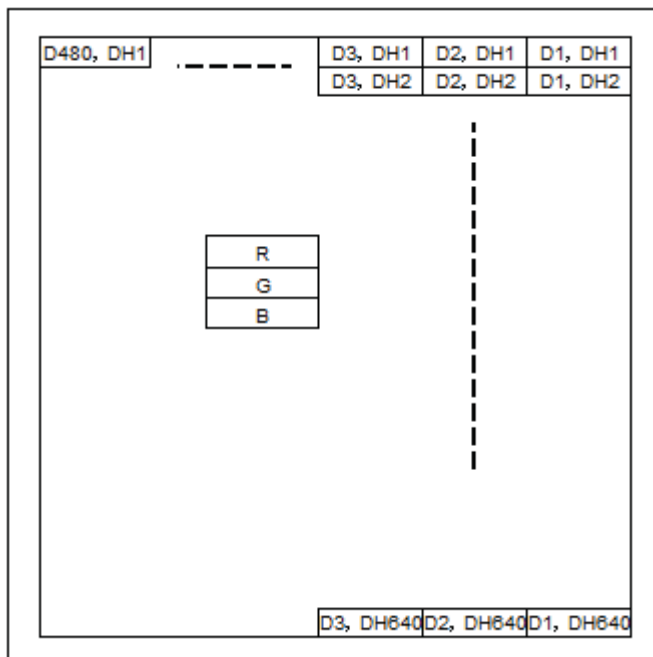

### 8-3. Input timing characteristics

#### 1) Horizontal timing

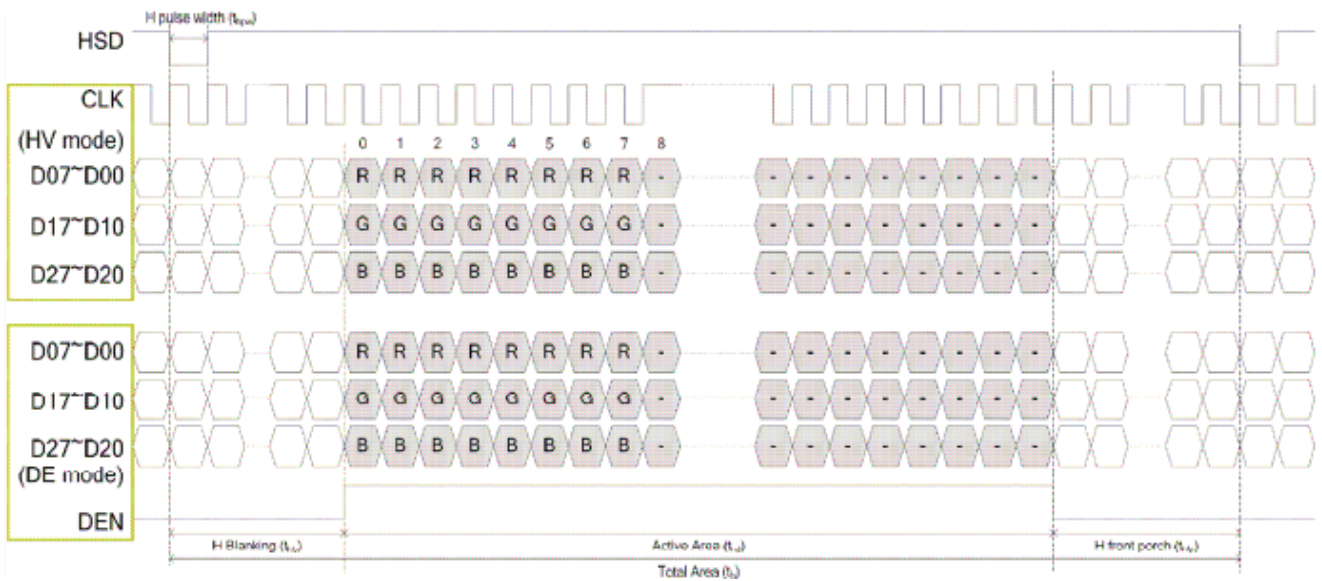

#### 2) Horizontal timing

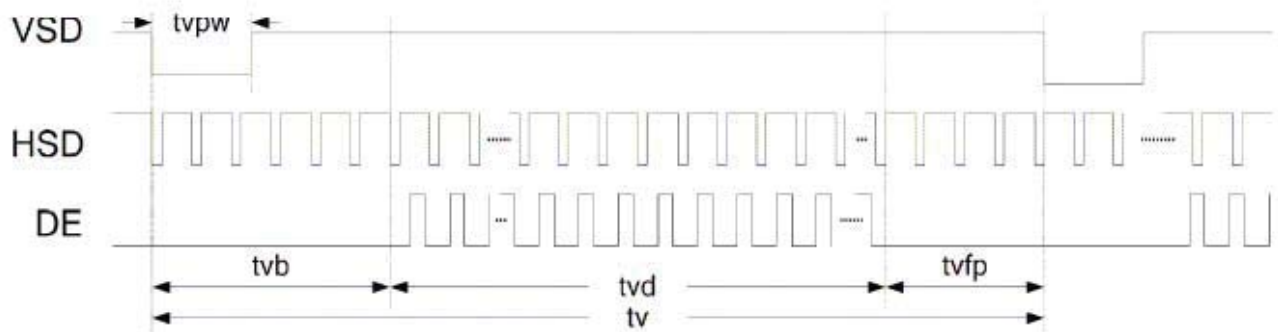

## 9. Backlight characteristics

Item	Symbol	Min.	Typ.	Max.	Unit	Note
Forward current 1)	IF	-	(60)	-	mA	Ta=-30~80°C
Forward voltage 1)	VF	-	(19.7)	(21.6)	V	IF=60mA, Ta=-30°C
		-	(18.4)	(20.4)	V	IF=60mA, Ta=25°C
		-	(17.8)	(19.7)	V	IF=60mA, Ta=80°C
Operating life time 2), 3)	T	-	(50,000)	-	h	IF=60mA, Ta=25°C

- 1) For each "AN-CA"
- 2) When brightness decrease 50% of minimum brightness.  
The average life of a LED will decrease when the LCD is operating at higher temperatures.
- 3) Life time is estimated data.(Condition : IF=60mA, Ta=25°C in chamber).
- 4) An input current below 15mA may reduce the brightness uniformity of the LED backlight. This is because the amount of light from each LED chip is different. Therefore, please evaluate carefully before finalizing the input current.

## 10. Lot number identification

The production lot number is specified as follows.

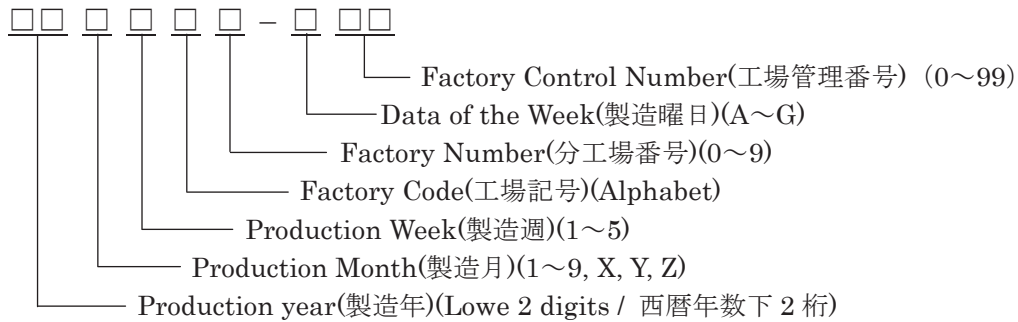

## 11. Warranty

### 11-1. Incoming inspection

Please inspect the LCD within one month after your receipt.

### 11-2. Production warranty

Kyocera warrants its LCD's for a period of 12 months from the ship date. Kyocera shall, by mutual agreement, replace or re-work defective LCD's that are shown to be Kyocera's responsibility.

Spec No. TQ3C-8EAF0-E1YAW02-00	Part No. T-55923GD050J-LW-ABN	Page 12
-----------------------------------	----------------------------------	------------

## 12. Precautions for use

### 12-1. Installation of the LCD

- 1) Please ground either of the mounting (screw) holes located at each corner of an LCD, in order to stabilize brightness and display quality.
- 2) A transparent protection plate shall be added to protect the LCD and its polarizer
- 3) The LCD shall be installed so that there is no pressure on the LSI chips.
- 4) The LCD shall be installed flat, without twisting or bending.
- 5) A transparent protection sheet is attached to the polarizer. Please remove the protection film slowly before use, paying attention to static electricity.

### 12-2. Static electricity

- 1) Since CMOS ICs are mounted directly onto the LCD glass, protection from static electricity is required.
- 2) Workers should use body grounding. Operator should wear ground straps.

### 12-3. LCD operation

- 1) The LCD shall be operated within the limits specified. Operation at values outside of these limits may shorten life, and/or harm display images.

### 12-4. Storage

- 1) The LCD shall be stored within the temperature and humidity limits specified.  
Store in a dark area, and protect the LCD from direct sunlight or fluorescent light.
- 2) Always store the LCD so that it is free from external pressure onto it.

### 12-5. Usage

- 1) **DO NOT** store in a high humidity environment for extended periods. Polarizer degradation bubbles, and/or peeling off of the polarizer may result.
- 2) The front polarizer is easily scratched or damaged. Prevent touching it with any hard material, and from being pushed or rubbed.
- 3) The LCD screen may be cleaned by wiping the screen surface with a soft cloth or cotton pad using a little Ethanol.
- 4) Water may cause damage or discoloration of the polarizer. Clean condensation or moisture from any source immediately.
- 5) Always keep the LCD free from condensation during testing. Condensation may permanently spot or stain the polarizer.
- 6) Do not disassemble LCD because it will result in damage.
- 7) This Kyocera LCD has been specifically designed for use in general electronic devices, but not for use in a special environment such as usage in an active gas. Hence, when the LCD is supposed to be used in a special environment, evaluate the LCD thoroughly beforehand and do not expose the LCD to chemicals such as an active gas.
- 8) Please do not use solid-base image pattern for long hours because a temporary afterimage may appear. We recommend using screen saver etc. in cases where a solid-base image pattern must be used.
- 9) Liquid crystal may leak when the LCD is broken. Be careful not to let the fluid go into your eyes and mouth. In the case the fluid touches your body; rinse it off right away with water and soap.

### 13. Reliability test data

Test item	Test condition	Test time	Judgement
High temp. atmosphere	80°C	240h	Display function : No defect Display quality : No defect
Low temp. atmosphere	-30°C	240h	Display function : No defect Display quality : No defect
High temp. humidity atmosphere	40°C 90% RH	240h	Display function : No defect Display quality : No defect
Temp. cycle	-30°C 1.0h 80°C 0.5h	100cycles	Display function : No defect Display quality : No defect
High temp. operation	80°C	240h	Display function : No defect Display quality : No defect
ESD	Contact discharge (Operation) 150pF, 330Ω, ±8kV	10 times at 1 sec interval	Display function : No defect Display quality : No defect
ESD	Signal pin discharge (Non-operation) 200pF, 0Ω, ±200V	10 times at 1 sec interval	Display function : No defect Display quality : No defect

- 1) Each test item uses a test LCD only once. The tested LCD is not used in any other tests.
- 2) The LCD is tested in circumstances in which there is no condensation.
- 3) The reliability test is not an out-going inspection.
- 4) The result of the reliability test is for your reference purpose only.  
The reliability test is conducted only to examine the LCD's capability.



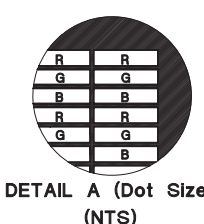
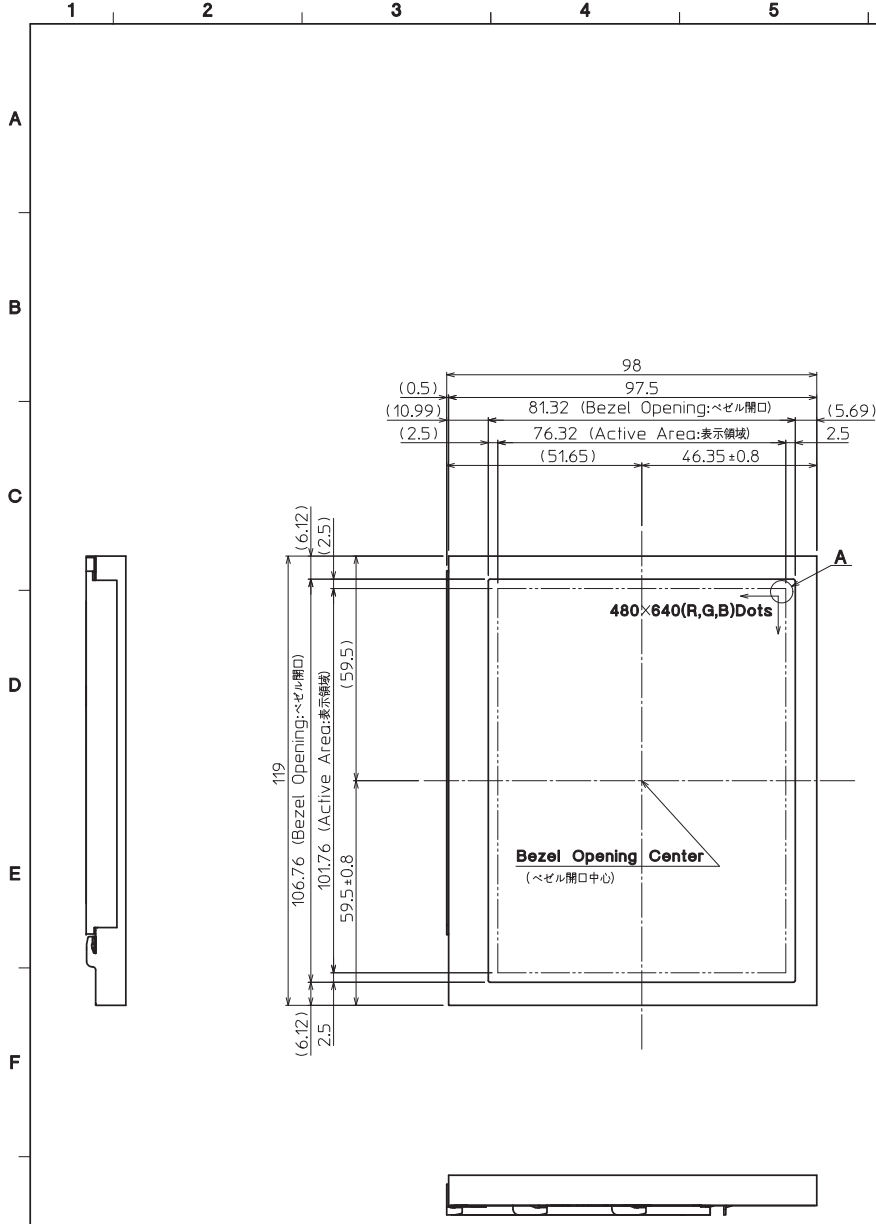

**TENTATIVE**

It is possible to change some dimensions.  
(本図記載の形状・及び寸法値は変更の可能性があります)

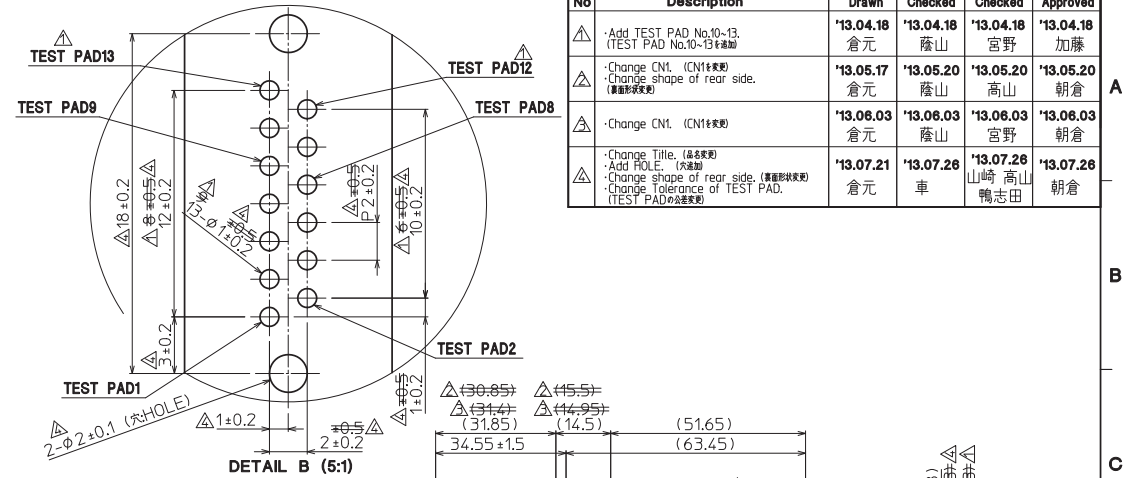

No	Description	Drawn	Checked	Checked	Approved
△	Add TEST PAD No.10-13. (TEST PAD No.10-13を添加)	'13.04.18 倉元	'13.04.18 蔭山	'13.04.18 宮野	'13.04.18 加藤
△	Change CN1. (CN1を変更) Change shape of rear side. (裏面形状変更)	'13.05.17 倉元	'13.05.20 蔭山	'13.05.20 高山	'13.05.20 朝倉
△	Change CN1. (CN1を変更)	'13.06.03 倉元	'13.06.03 蔭山	'13.06.03 宮野	'13.06.03 朝倉
△	Change Title. (品名変更) Add HOLE. (穴追加) Change shape of rear side. (裏面形状変更) Change Tolerance of TEST PAD. (TEST PADの公差変更)	'13.07.21 倉元	'13.07.26 車	'13.07.26 山崎 高山 鴨志田	'13.07.26 朝倉

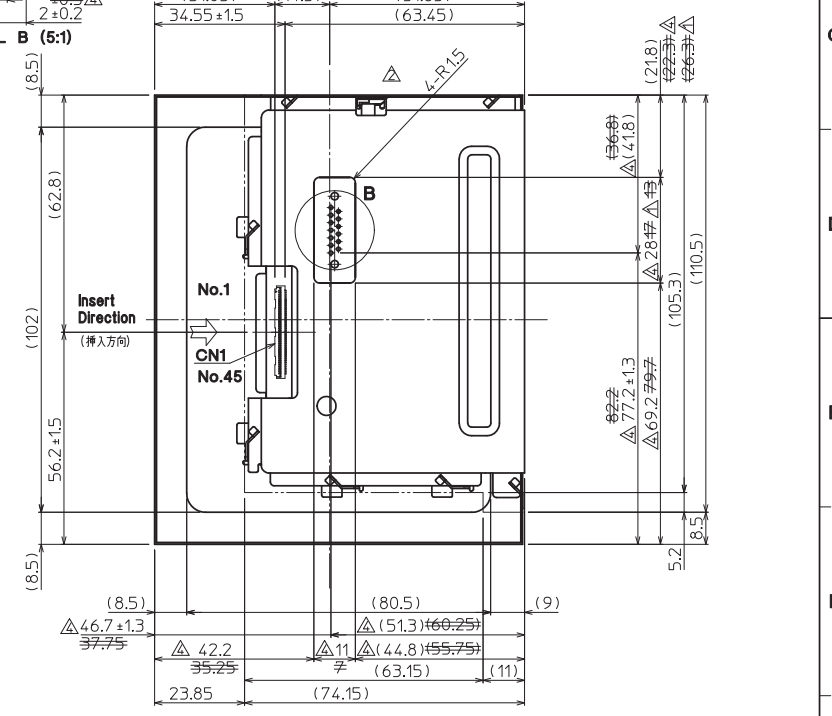

- △ 54296-4594 (motex)  
△ 64-6299-045-020-846- (KYOCERA Connector Products)  
(コネクタ)
- Note. (注記)
- Connector CN1: FH33-45S-0.5SH(10) (HIROSE)
  - The information of LCD is displayed starting at the upper right hand corner, moving down then left to the lower left hand corner.  
(LCDにおいて、画像データの表示は右上コーナーから始まり、下へ進み左へ送られ左下コーナーへ向かう。)
  - Tolerance without indication: ±0.5  
(指示無き公差)

Material	Treatment	Approved	Checked	Checked	Drawn	Scale	Title	Year-Month-Day	Size
材質	処理	'13.04.17		'13.04.17	倉元	1:1 (NTS,5:1)	T-55923AB base T12A	'13.04.15	2
Quantity	Description;						Outline Dimensions		
製作数	備考	朝倉		蔭山				13107-06448-4	

Spec No.	TQ3C-8EAF0-E2YAW02-00
Date	August 5, 2013

**KYOCERA INSPECTION STANDARD**

**TYPE : T-55923GD050J-LW-ABN**  
**(TCG050VGLP\*ANN-AN\*02)**

KYOCERA DISPLAY CORPORATION

Original Issue Date	Designed by : Engineering dept.			Confirmed by : QA dept.	
	Prepared	Checked	Approved	Checked	Approved
August 5, 2013	<i>K. Mori</i>	<i>Y. Yamaguchi</i>	<i>M. Fujitani</i>	<i>O. Sato</i>	<i>T. Okamoto</i>

Spec No.  
TQ3C-8EAF0-E2YAW02-00

Part No.  
T-55923GD050J-LW-ABN

Page  
-

**Revision record**

Date	Designed by : Engineering dept.			Confirmed by : QA dept.	
	Prepared	Checked	Approved	Checked	Approved
August 5, 2013					
Rev.No.	Date	Page	Descriptions		

## Visuals specification

### 1) Note

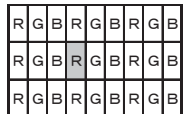
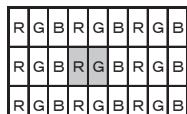
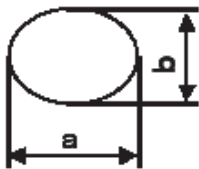
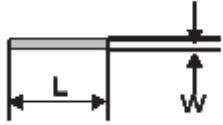
		Note	
General	<p>1. Customer identified anomalies not defined within this inspection standard shall be reviewed by Kyocera, and an additional standard shall be determined by mutual consent.</p> <p>2. This inspection standard about the image quality shall be applied to any defect within the active area and shall not be applicable to outside of the area.</p> <p>3. Inspection conditions</p> <p>Luminance : 300~500 Lux min.</p> <p>Inspection distance : 350 mm.</p> <p>Temperature : Approximate 25°C</p> <p>Direction : Normal to the LCD panel ±10° horizontal and vertical</p>		
Definition of inspection item	Dot defect	Bright dot defect	<p>The dot is constantly “on” when power applied to the LCD, even when all “Black” data sent to the screen.</p> <p>Inspection tool: 5% Transparency neutral density filter.</p> <p>Count dot: If the dot is visible through the filter.</p> <p>Don't count dot: If the dot is not visible through the filter.</p> <div style="text-align: center;">  </div>
		Black dot defect	<p>The dot is constantly “off” when power applied to the LCD, even when all “White” data sent to the screen.</p>
		Adjacent dot	<p>Adjacent dot defect is defined as two or more bright dot defects or black dot defects.</p> <div style="text-align: center;">  </div>
		Definition of size	<p>Definition of circle size</p> <div style="text-align: center;">  <p><math>\Phi = (a + b) / 2</math></p> </div> <p>Definition of linear size</p> <div style="text-align: center;">  </div>

Spec No. TQ3C-8EAF0-E2YAW02-00	Part No. T-55923GD050J-LW-ABN	Page 2
-----------------------------------	----------------------------------	-----------

## 2) Standard

Defect Type		Limit	
Visual defect	Scratch	$0.01 \text{ mm} < W \leq 0.05 \text{ mm}$	$N \leq 4$
		$L \leq 10 \text{ mm}$	
		$0.01 \text{ mm} < W$ $10 \text{ mm} < L$	$N = 0$
	Dent	$0.05 \text{ mm} < W$	$N = 0$
		$0.2 \text{ mm} < \Phi \leq 0.4 \text{ mm}$	$N \leq 4$
	Black spot bubble	$0.4 \text{ mm} < \Phi$	$N = 0$
		$0.2 \text{ mm} < \Phi \leq 0.4 \text{ mm}$	$N \leq 5$
	Lint	$0.4 \text{ mm} < \Phi$	$N = 0$
		$L \leq 3 \text{ mm}$	$N \leq 4$
		$W \leq 0.1 \text{ mm}$	
		$3 \text{ mm} \leq L$ $W \leq 0.1 \text{ mm}$	$N = 0$
	Electrical defect	Bright dot	$0.1 \text{ mm} < W$
Bright dot		$N \leq 5$	
Dark dot		$N \leq 5$	
Total dot		$N \leq 8$	
Two adjacent dot			
Bright dot		$\leq 2 \text{ pairs}$	
Dark dot	$\leq 2 \text{ pairs}$		
Three or more adjacent dot	Not allowed		
Line defect	Not allowed		
Moire	All Moire is out of inspection.		